

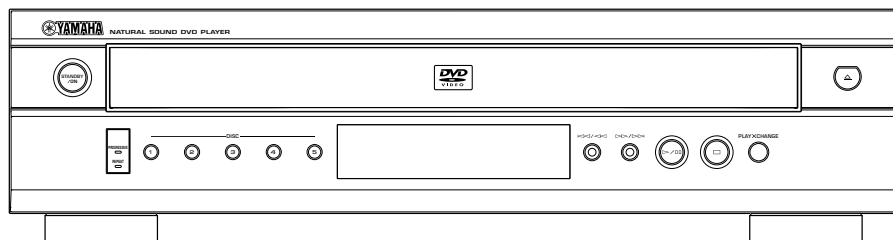

DVD CHANGER
LECTEUR DE DVD CHANGEUR

DVD-C740

OWNER'S MANUAL
MODE D'EMPLOI





This symbol warns the user that uninsulated voltage within the unit may have sufficient magnitude to cause electric shock. Therefore, it is dangerous to make any kind of contact with any inside part of this unit.



This symbol alerts the user that important literature concerning the operation and maintenance of this unit has been included. Therefore, it should be read carefully in order to avoid any problems.

WARNING



To reduce the risk of fire or electric shock, do not expose this appliance to rain or moisture.

CAUTION

Use of controls or adjustments or performance of procedures other than herein may result in hazardous radiation exposure.

The set complies with the FCC-Rules, Part 15 and with 21 CFR 1040.10.

IMPORTANT SAFETY INSTRUCTIONS

1. Read these instructions.
2. Keep these instructions.
3. Heed all warnings.
4. Follow all instructions.
5. Do not use this apparatus near water.
6. Clean only with a dry cloth.
7. Do not block any of the ventilation openings. Install in accordance with the manufacturers instructions.
8. Do not install near any heat sources such as radiators, heat registers, stoves, or other apparatus (including amplifiers) that produce heat.
9. Do not defeat the safety purpose of the polarized or grounding-type plug. A polarized plug has two blades with one wider than the other. A grounding type plug has two blades and a third grounding prong. The wide blade or the third prong are provided for your safety. When the provided plug does not fit into your outlet, consult an electrician for replacement of the obsolete outlet.
10. Protect the power cord from being walked on or pinched, particularly at plugs, convenience receptacles, and the point where they exit from the apparatus.
11. Only use attachments/accessories specified by the manufacturer.
12.  Use only with a cart, stand, tripod, bracket, or table specified by the manufacturer or sold with the apparatus. When a cart is used, use caution when moving the cart/apparatus combination to avoid injury from tip-over.
13. Unplug this apparatus during lightning storms or when unused for long periods of time.
14. Refer all servicing to qualified service personnel. Servicing is required when the apparatus has been damaged in any way, such as if the power-supply cord or plug is damaged, liquid has been spilled or objects have fallen into the apparatus, or when the apparatus has been exposed to rain or moisture, does not operate normally, or has been dropped.
15. Battery usage **CAUTION** – To prevent battery leakage which may result in bodily injury or damage to the unit. Install **all** batteries correctly, + and - as marked on the unit. Do not mix batteries (**old** and **new** or **carbon** and **alkaline**, etc.). Remove batteries when the unit is not used for a long time.

EL 6475-E002: 01/3

FCC INFORMATION (for US customers)

1. IMPORTANT NOTICE: DO NOT MODIFY THIS UNIT!

This product, when installed as indicated in the instructions contained in this manual, meets FCC requirements. Modifications not expressly approved by Yamaha may void your authority, granted by the FCC, to use the product.

2. IMPORTANT: When connecting this product to accessories and/or another product use only high quality shielded cables. Cable/s supplied with this product **MUST** be used. Follow all installation instructions. Failure to follow instructions could void your FCC authorization to use this product in the USA.

3. NOTE: This product has been tested and found to comply with the requirements listed in FCC Regulations, Part 15 for Class "B" digital devices. Compliance with these requirements provides a reasonable level of assurance that your use of this product in a residential environment will not result in harmful interference with other electronic devices. This equipment generates/uses radio frequencies and, if not installed and used according to the instructions found in the users manual, may cause interference harmful to the operation of other electronic devices. Compliance with FCC regulations does not guarantee that interference will not occur in all installations. If this product is found to be the source of interference, which can be determined by turning the product "OFF" and "ON", please try to eliminate the problem by using one of the following measures: Relocate either this product or the device that is being affected by the interference.

Utilize power outlets that are on different branch (circuit breaker or fuse) circuits or install AC line filters.

In the case of radio or TV interference, relocate/reorient the antenna. If the antenna lead-in is 300 ohm ribbon lead, change the lead-in to coaxial type cable.

If these corrective measures do not produce satisfactory results, please contact the local retailer authorized to distribute this type of product. If you can not locate the appropriate retailer, please contact Yamaha Electronics Corp., 6600 Orangethorpe Ave. Buena Park, CA90622.

The above statements apply **ONLY** to those products distributed by Yamaha Corporation of America or its subsidiaries.

We Want You Listening For A Lifetime

YAMAHA and the Electronic Industries Association's Consumer Electronics Group want you to get the most out of your equipment by playing it at a safe level. One that lets the sound come through loud and clear without annoying blaring or distortion - and, most importantly, without affecting your sensitive hearing.

Since hearing damage from loud sounds is often undetectable until it is too late, YAMAHA and the Electronic Industries Association's Consumer Electronics Group recommend you to avoid prolonged exposure from excessive volume levels.



For Customer Use:

Read carefully the information located at the rear panel of the player and enter below the Serial No. Retain this information for future reference.

Model No. _____
Serial No. _____

FOR CANADIAN CUSTOMERS

To prevent electric shock, match wide blade of plug to wide slot and fully insert.

This Class B digital apparatus complies with Canadian ICES-003.

This digital apparatus does not exceed the Class B limits for radio noise emissions from digital apparatus as set out in the Radio Interference Regulations of the Canadian Department of Communications.

WARNING

TO REDUCE THE RISK OF FIRE OR ELECTRIC SHOCK, DO NOT EXPOSE THIS UNIT TO RAIN OR MOISTURE.

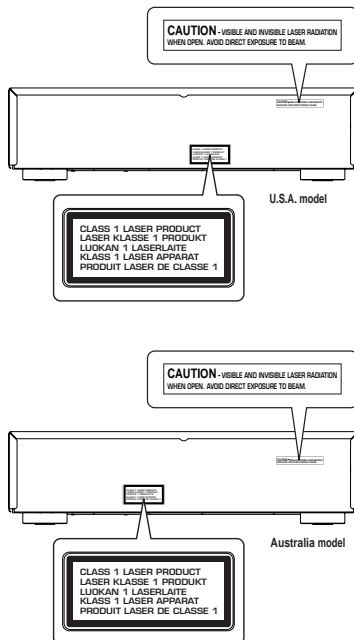

CAUTION: READ THIS BEFORE OPERATING YOUR UNIT.

- 1 To assure the finest performance, please read this manual carefully. Keep it in a safe place for future reference.
- 2 Install this unit in a well ventilated, cool, dry, clean place — away from direct sunlight, heat sources, vibration, dust, moisture, or cold. In a cabinet, allow about 2.5cm (1 inch) of free space all around this unit for adequate ventilation.
- 3 Locate this unit away from other electrical appliances, motors, or transformers to avoid humming sounds.
- 4 Do not expose this unit to sudden temperature changes from cold to hot, nor locate this unit in an environment with high humidity (i.e., a room with a humidifier) to prevent condensation inside this unit, which may cause an electrical shock, fire, damage to this unit, and/or personal injury.
- 5 Avoid installing this unit in a location where foreign objects may fall onto this unit or where this unit may be exposed to liquid dripping or splashing. On the top of this unit, do not place:
 - Other components, as they may cause damage and/or discoloration on the surface of this unit.
 - Burning objects (i.e., candles), as they may cause fire, damage to this unit, and/or personal injury.
 - Containers with liquid in them, as they may fall, spilling the liquid and causing an electrical shock to the user and/or damage to this unit.
- 6 Do not cover this unit with a newspaper, tablecloth, curtain, etc. in order not to obstruct heat radiation. If the temperature inside this unit rises, it may cause fire, damage to this unit, and/or personal injury.
- 7 Do not plug in this unit to a wall outlet until all connections are complete.
- 8 Do not operate this unit upside-down. It may overheat, possibly causing damage.
- 9 Do not use excessive force on switches, knobs and/or cords.
- 10 When disconnecting the power cord from the wall outlet, grasp the plug; do not pull the cord.
- 11 Do not clean this unit with chemical solvents; this might damage the finish. Use a clean, dry cloth.
- 12 Use only the voltage specified on this unit. Using this unit with a higher voltage than specified is dangerous and may cause fire, damage to this unit, and/or personal injury. YAMAHA will not be held responsible for any damage resulting from use of this unit with a voltage other than as specified.
- 13 To prevent damage by lightning, disconnect the power cord from the wall outlet during an electrical storm.

- 14 Do not attempt to modify or fix this unit. Contact qualified YAMAHA service personnel when any service is needed. The cabinet should never be opened for any reason.
- 15 When not planning to use this unit for long periods of time (i.e., vacation), disconnect the AC power plug from the wall outlet.
- 16 Be sure to read the “Troubleshooting” section on common operating errors before concluding that this unit is faulty.
- 17 Before moving this unit, press STANDBY/ON to set the unit in standby mode, then disconnect the AC power plug from the wall outlet.

The unit is not disconnected from the AC power source as long as it is connected to the wall outlet, even if this unit itself is turned off. This state is called the standby mode. In this state, this unit is designed to consume a very small quantity of power.

NOTE:

Pictures shown maybe different between countries. Never make or change connections with the power switched on.

LASER SAFETY

This unit employs a laser. Due to possible eye injury, only a qualified service person should remove the cover or attempt to service this device.

CAUTION

VISIBLE AND INVISIBLE LASER RADIATION WHEN OPEN. AVOID EXPOSURE TO BEAM

Use of controls or adjustments or performance of procedures other than those specified herein may result in hazardous radiation exposure.

This unit is designed for home use only. Do not use this unit for business purposes.

Be sure to place this unit on a level surface.

If not so, this unit will fail to work normally at the PLAY/CHANGE operation and cause damage to the disc(s) and this unit itself.

LASER

Type	Semiconductor laser GaAlAs
Wave length	650 nm (DVD) 780 nm (VCD/CD)
Output Power	7 mW (DVD) 10 mW (VCD/CD)
Beam divergence	60 degree

Introduction

Supplied accessories	2
Notes about discs	2
Cleaning discs.....	2
Symbols Used in this Manual	2

Functional Overview

Front Panel	3
Rear Panel	4
Remote Control	5

Preparation

General Notes on connections	6
Digital Connections	6
Analog Connections.....	6
Video Connections.....	6
S-Video jacks.....	7
Component Video jacks.....	7
Composite Video jacks	7
Inserting batteries into the Remote Control	8
Using the Remote Control	8
NTSC/PAL Conversion	8
Switching On	8
Menu Bars on TV Screen	9
Temporary Feedback Field Icons.....	9
User Preference Settings.....	9
General operation.....	9
Picture.....	10
Sound	11
Language.....	13
Features.....	13
Other Feature.....	13

Operation

Basic Playback	14
Playing a DVD-Video.....	14
Playing a title.....	14
Resume.....	14
Video CD and Super Video CD	15
Playing a disc.....	15
Playing an Audio CD	15
Playing a disc.....	15
Special DVD Features	16
Title/Disc menu	16
Camera Angle.....	16
Changing the audio language.....	16
Subtitle Language.....	16
Special VCD & SVCD Features.....	16
Playback Control (PBC).....	16
Special CD & MP3 Features.....	16
CD text and MP3 text	16

General Features	17
Moving to another title/chapter	17
Search.....	17
Slow Motion.....	17
Still Picture and Frame-by-frame playback.....	17
Scan	17
Repeat.....	18
Repeat A-B.....	18
Shuffle Across All Discs.....	18
Time search	18
Zoom	18
Favorite Track Selection Across Disc	19
FTS for a Single disc	19
MP3 Disc Features	20
Album/Title Playback.....	21
Repeat track/album/Disc.....	21

Access Control

Child Lock.....	22
Activating/deactivating the Child Lock.....	22
Authorising discs	22
Deauthorising discs.....	22
Parental Control.....	22
Activating/Deactivating Parental Control.....	23
Country	23
Changing the 4-digit code	23
If you forget your 4 digit code.....	23
Parental Control Disclaimer	23

Troubleshooting 24

Specifications 25

Introduction

Thank you for purchasing this YAMAHA DVD player. This Owner's Manual explains the basic operation of this DVD player.

Supplied accessories

- Remote control
- Batteries (two AA size) for remote control
- Audio/Video cable
- Owner's Manual

Notes about discs

- *This unit is designed for use with DVD video, Video CD, Super video CD, Audio CD (CD text supported), CD-R and CD-RW (MP3 Supported), DVD+RW and DVD+R.*
- *CD-R and CD-RW cannot be played unless finalized.*
- *Some discs cannot be played depending on the disc characteristics or recording conditions.*
- *Be sure to use only CD-R and CD-RW discs made by reliable manufacturers.*
- *Do not use any non standard shaped discs (heart, etc.)*
- *Do not use disc with tape, scals, or paste on it, damage to the unit may result.*
- *Do not use a disc printed on its surface by a commercially available label printer.*

Cleaning discs



- When a disc becomes dirty, clean it with a cleaning cloth. Wipe the disc from the centre out. Do not wipe in a circular motion.
- Do not use solvents such as benzine, thinner, commercially available cleaners, or antistatic spray intended for analogue records.

Manufactured under license from Dolby Laboratories. "Dolby" and the double-D symbol are trademarks of Dolby Laboratories.

"DTS" and "DTS Digital Out" are trademarks of Digital Theater Systems, Inc.

Symbols Used in this Manual

The below symbols appear in some headings and notes with the following meanings:

	- Description refers to playback of DVD-video discs
	- Description refers to playback of Video CDs
	- Description refers to playback of Audio CDs

Helpful Hints!

- **Some DVD video discs require specific functions or allow only limited functions during playback.**
- **"" may appears on the TV screen which means that the function is not available on that specific DVD video disc.**

This product incorporates copyright protection technology that is protected by method claims of certain U.S. patents and other intellectual property rights owned by Macrovision Corporation and other rights owners. Use of this copyright protection technology must be authorized by Macrovision Corporation, and is intended for home and other limited viewing uses only unless otherwise authorized by Macrovision Corporation. Reverse engineering or disassembly is prohibited.

Front Panel

STANDBY/ON

- to switch the player to standby mode or ON

Disc Tray

- load up to 5 discs on the disc tray

▲ OPEN/CLOSE

- to open/close the disc tray



DISPLAY

- shows the current status of the player

DISC (1, 2, 3, 4, 5)/LEDs

- to select and directly playback the preferred disc / each LED flashes green when button is selected

LEDs

- LED lights up when the corresponding feature is set to ON



- search backward* / go to a previous chapter or track



- search forward* / go to the next chapter or track

▶|| PLAY/PAUSE

- to start or interrupt playback

■ STOP

- to stop playback

PLAYXCHANGE

- to change another disc(s) during playback

* Press button for about two seconds.

Functional Overview

Rear Panel

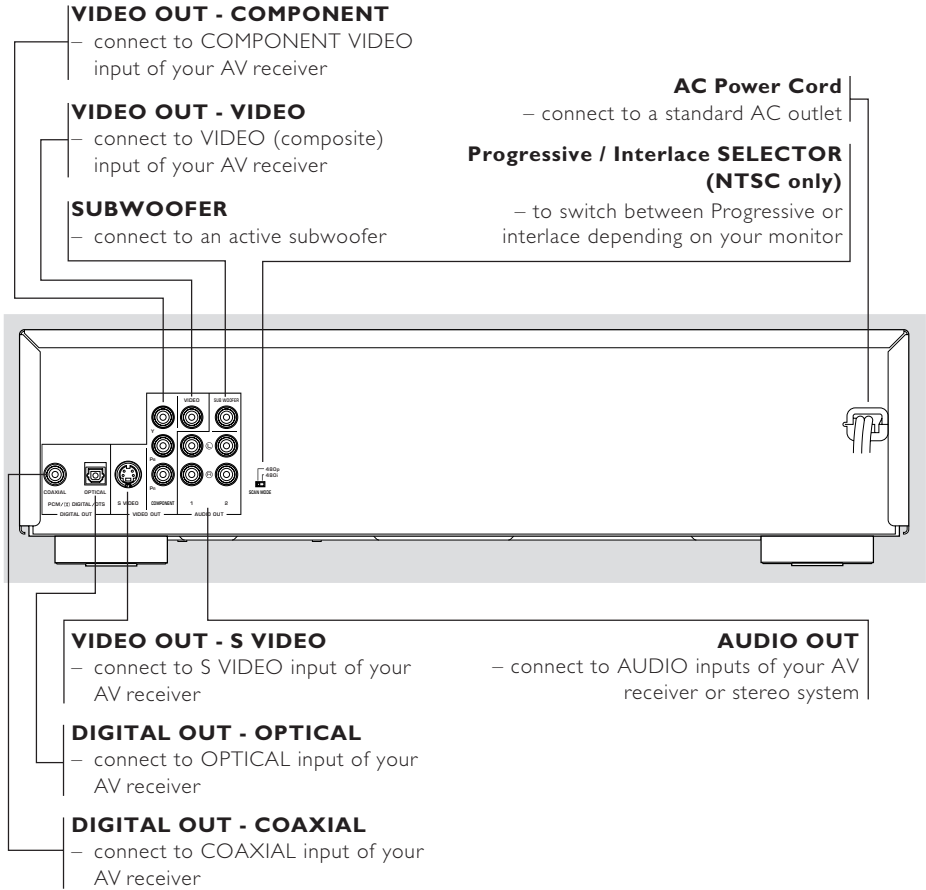

Caution: Do not touch the inner pins of the jacks on the rear panel. Electrostatic discharge may cause permanent damage to the player.

Remote Control

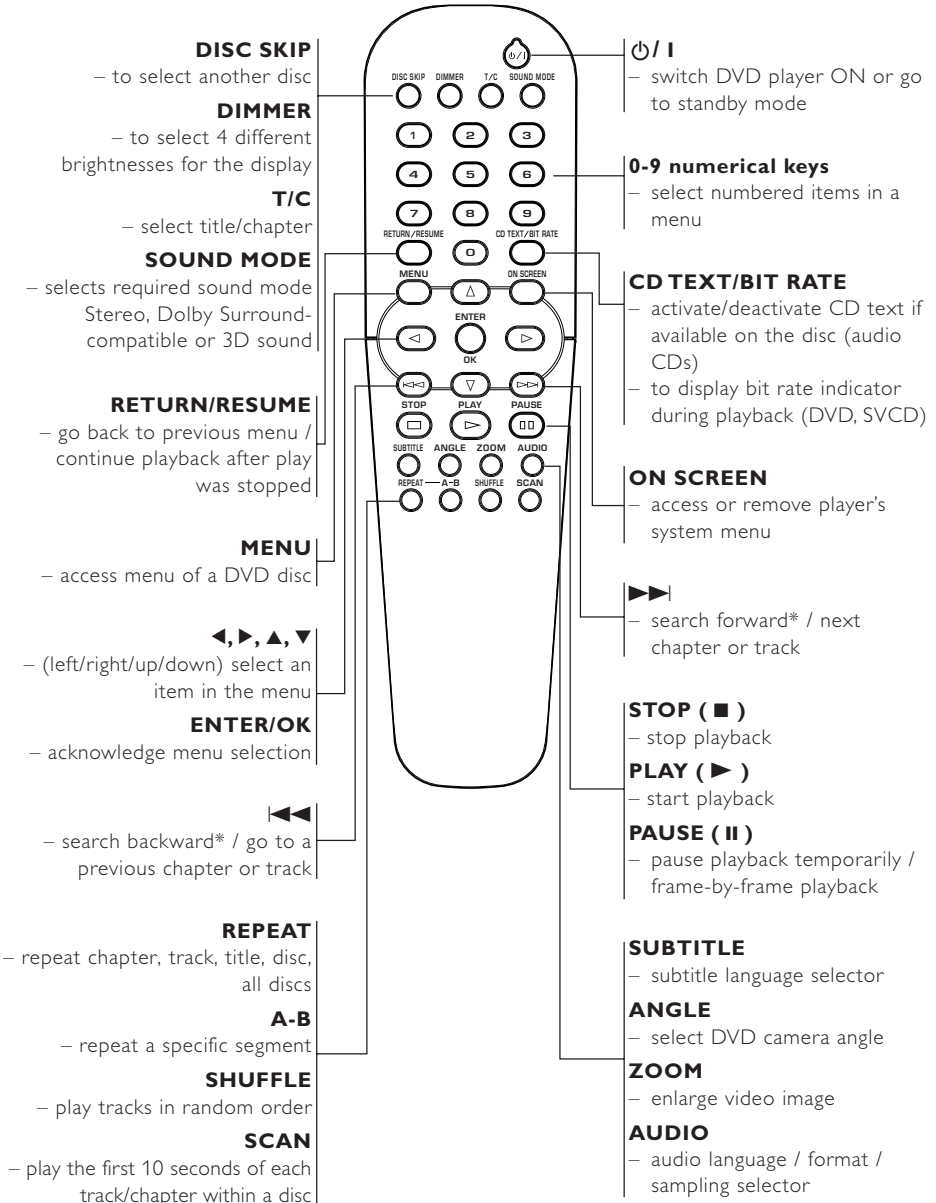

* Press and hold button for about two seconds.

Preparation

General Notes on connections

Never make or change connections with the power switched on.

- Depending on the equipment you wish to connect, there are various ways you could connect this player. Possible connections are shown in the following drawings.
- Please refer to the manuals of other equipment as necessary to make the best connections.
- Do not connect this player via your VCR. The video quality could be distorted by the copy protection system.
- Do not connect this player's audio out jack to the phono in jack of your audio system.

Digital Connections

This player has COAXIAL and OPTICAL digital out jacks. Connect one or both of them to your AV receiver equipped with Dolby digital, DTS, or MPEG decoder using each specific cable (separate purchase).

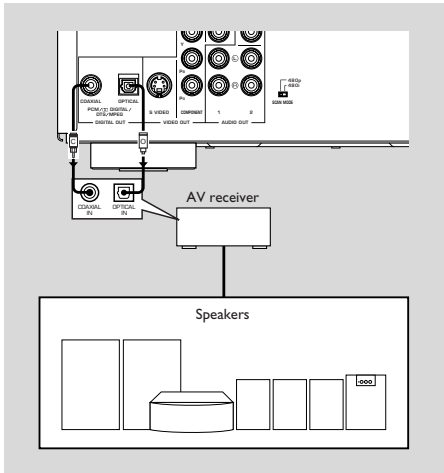

You will need to set this player's digital output to ALL (see 'User Preference Settings').

Notes:

- If the audio format of the digital output does not match the capabilities of your receiver, the receiver will produce a strong, distorted sound or no sound at all. Make sure to select the appropriate audio format at menu screen included on the disc. Pressing AUDIO once or more may change not only audio languages but also audio formats, and the selected format appears for several seconds on the status window.
- MP3 Audio is not available on the Digital Output.

Analog Connections

Use audio/video cable supplied with this player to connect the AUDIO OUT L (left) and R (right) jacks to corresponding input jacks of your audio equipment such as Stereo amplifier. You can connect a subwoofer to the SUBWOOFER jack.

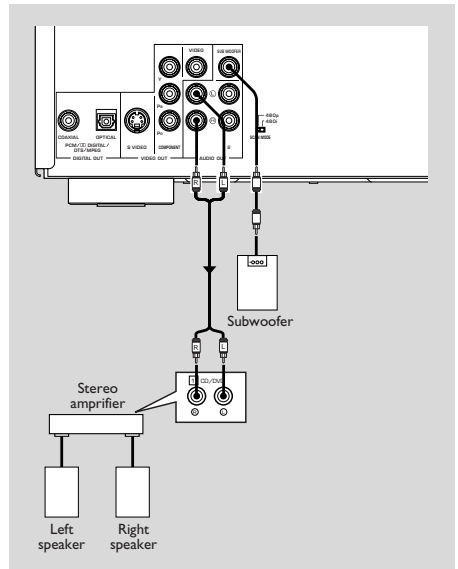

Video Connections

If your AV receiver has video output jacks, connect your receiver (and then to your TV) so that you can use one TV for several different video sources (LD, VCR etc.) by simply switching the input source selector of your receiver. The player has three types of video output jacks. Use one of them in accordance with the input jacks of the equipment to be connected.

S-Video jacks <A>

S (separate) video connection achieves a clearer picture than composite video connection by separating color and luminance when transmitting signals. Use commercially available S-video cable. Receiver (and TV) with S-video input is required.

Component Video jacks

Component video connection achieves high fidelity in reproducing colors (better performance than S-video connection), separating video signal into luminance (Y, terminal color-coded as green), and color difference (Pb, blue/Pr, red).

SCAN MODE selector

This switch will change the type of NTSC signal output from the Pr/Cr Pb/Cb Y VIDEO OUT on the player.

480p:

Select progressive when you have a TV that can accept progressive signals to enjoy accurate colour reproduction and high quality images.

480i:

Select this setting when connected to a standard (interlace format) TV.

Use commercially available coaxial cables. Receiver (and TV) with component input is required. Observe the color of each jack when connecting. If your receiver does not have component output jacks, connecting the player's component output directly to your TV's component input can reproduce better video image.

Composite Video jacks <C>

Use audio/video cable supplied with this player when connecting the player to a TV.

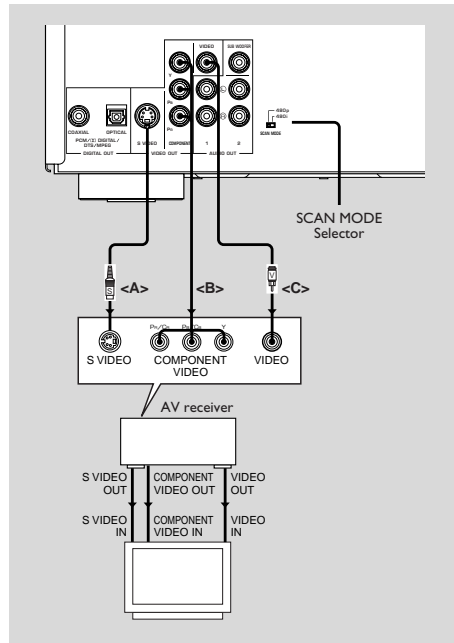

CONSUMERS SHOULD NOTE THAT NOT ALL HIGH DEFINITION TELEVISION SETS ARE FULLY COMPATIBLE WITH THIS PRODUCT AND MAY CAUSE ARTIFACTS TO BE DISPLAYED IN THE PICTURE. IN CASE OF 525 PROGRESSIVE SCAN PICTURE PROBLEMS, IT IS RECOMMENDED THAT THE USER SWITCH THE CONNECTION TO THE "STANDARD DEFINITION" OUTPUT. IF THERE ARE QUESTIONS REGARDING OUR VIDEO MONITOR COMPATIBILITY WITH THIS MODEL 525P DVD PLAYER, PLEASE CONTACT OUR CUSTOMER SERVICE CENTER.

This unit is compatible with the complete line of YAMAHA projectors, including the DPX-1, LPX-500, PDM-1 and DPX-1000.

Preparation

Inserting batteries into the Remote Control

- 1 Open the battery cover.
- 2 Insert batteries (AA size) with the correct polarity as indicated by the + and - symbols inside the battery compartment.
- 3 Close the cover.

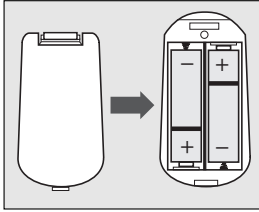

CAUTION!

- Remove batteries if they are exhausted or not to be used for a long time.
- Do not use old and new or different types of batteries in combination.
- Batteries contain chemical substances, so they should be disposed off properly and kept away from children.

Using the Remote Control

- Direct the remote control at the remote sensor of the player.
- Do not drop the remote control.
- Do not leave the remote control near extremely hot or humid places.
- Do not spill water or put anything wet on the remote control.

NTSC/PAL Conversion

DVD discs are recorded according to color system eg. NTSC and PAL. Your TV also operates according to a color system.

This DVD player is compatible with NTSC and PAL. To play on this DVD player, the color system of the DVD disc, the TV and the DVD player should match. If all three are not the same, the DVD may play in only black and white, the picture may roll continuously or the picture may appear distorted.

To activate the conversion, refer to page 11.

Switching On

- 1 Connect the AC power cord to the power outlet.
- 2 Switch on the TV and DVD player.
- 3 Select the correct input channel at your TV and set the input source at your AV receiver to DVD.
→ The player display lights up and the default screen appears on the TV.
- 4 If you are using an external equipment (eg. audio system or receiver), turn them on and select the appropriate input source that was used to connect to the player output. Refer to the equipment owner's manual for detail.

Note:

- If you do not have a proper picture or sound, refer to 'Troubleshooting' section.

Menu Bars on TV Screen

- Operations can be carried out directly via the multiple menu bars on the TV screen.
- The following functions are available via the menu bars. Pressing ON SCREEN repeatedly will toggle through menu bar 1, menu bar 2, menu bar 3 and menu bar OFF:

Menu bar 1



From the left,
 User Preference Settings →
 Current Subtitle Language →
 Current Audio Language → Smart Color →
 Sound Mode

The following functions are available with activated disc via the menu bars:

Menu bar 2



From the left,
 Frame by Frame → Slow Motion → Scan Speeds →
 Camera Angle → Enlarge Picture

Menu bar 3



From the left,
 Disc → Title → Chapter → Time Search →
 Favorite Track Selection

Temporary Feedback Field Icons

These icons will appear on the top left hand corner of your TV screen.

	Scan		Repeat A to end
	Repeat all discs		Repeat A-B
	Repeat disc		Angle
	Repeat Title		Child Lock On
	Repeat Track		Child Safe
	Repeat Chapter		Resume
	Shuffle all discs		Action Prohibited
	Shuffle		Movie only
	Shuffle Repeat		Music only
	PlayXchange		

User Preference Settings

In the User Preference Settings menu, you can customize your player to suit your own particular requirements.

General operation

- Press ON SCREEN on the remote control.
- The will be highlighted in the menu bar.
- Press ▼ to activate the Personal Preferences menu.

To select a preferred menu language,

- Press ▼ until is highlighted.
- Press ► to enter the submenu and ▼ to choose Menu language.
- Use ▲/▼ to select your preferred menu language.

For navigation and selection in Personal preferences,

- Use ◀, ▶, ▲, ▼ to toggle through the functions and select your preferred option.
- Press ENTER/OK to confirm a highlighted selection.

The following items are available:

Preparation

Picture

– TV Shape

Select the aspect ratio of the TV to be connected.

16:9 → when you connect a wide-screen TV to this player.

4:3 LETTER BOX → when you connect a normal TV to this player. Displays a wide picture with black bands displayed on the upper and lower portions of the TV screen.

4:3 PAN SCAN → when you connect a normal TV to this player. Displays the wide picture on the whole TV screen with a portion automatically cut off.

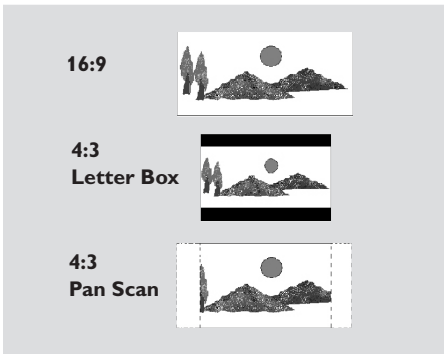

Note:

– Pan Scan is subject to availability on the disc.

– Black level shift (NTSC output only)

Select On for adapting the color dynamics to obtain richer contrasts.

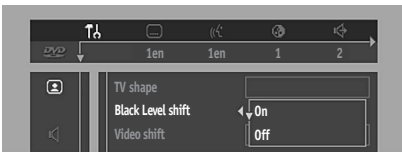

– Monitor Type

Allows you to select the type of display device that is connected to this unit.

In each device, a set of predefined Colour settings is available or choose Personal that allows you to select the colour settings according to your preference.

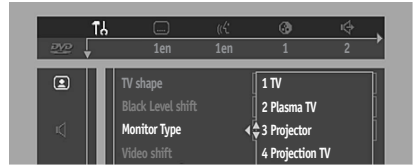

– Video shift

Use this setting to personalize the position of the picture on your TV by scrolling it to the left or right.

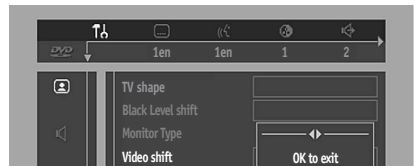

– Color settings

You can select one of five predefined sets of color settings and one set (Personal) which you can define yourself.

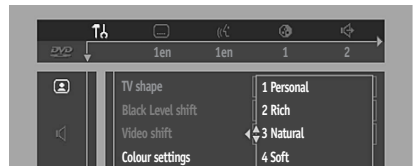

- When Personal is selected it allows you to fine-tune saturation, brightness and contrast.
- Use ▲ or ▼ to adjust the values of these parameters. Press ENTER/OK or ◀ to exit.

– TV System (NTSC/PAL Conversion)

Allows you to select between PAL, NTSC and AUTO mode depending on your TV.

The conversions supported are as follows:

Type	Disc	Output format		
		Selected mode		
		NTSC	PAL	AUTO
DVD	NTSC	NTSC	PAL60	NTSC
	PAL	Not Supported	PAL	PAL
VCD	NTSC	NTSC	PAL60	NTSC
	PAL	NTSC	PAL	PAL

- 1 In the Personal Preferences Menu, select TV System.
- 2 Press ▲ or ▼ to select PAL, NTSC or AUTO.

Notes:

- If you have a PAL only TV, ensure that your TV System setting is PAL.
- AUTO can only be selected when using a TV that supports both the NTSC and PAL systems (multisystems).
- This setting is applicable for CVBS output on cinch only.
- Slight picture distortions may occur due to this conversion. This is normal. Thus, the AUTO format is most suitable for the best picture quality.

Sound

– Digital output

- Digital output selection enables you to specify the type of digital output suitable for your receiver.
- Select ALL (default setting), if you had connected your DIGITAL AUDIO OUT to a multichannel decoder receiver.
- Select PCM only if your receiver is not capable of decoding compressed/encoded input stream.
- Select OFF to deactivate the DIGITAL AUDIO OUT.

Note:

- Digital output is not available for MP3 discs.

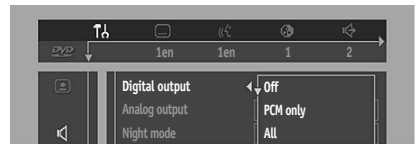

– Analog output

Select Stereo, Dolby Surround-compatible or 3D Sound.

Stereo: In this setting, the 5.1 audio channels are down-mixed to a stereo signal. Select this setting when connecting to a TV, stereo amplifier/receiver, etc.

Preparation

Dolby Surround-compatible: Select this setting when using an equipment with a Dolby Surround Pro Logic decoder. In this setting, the 5.1 audio channels (Dolby Digital, MPEG-2, DTS) are downmixed to a Dolby Surround-compatible 2-channel output.

3D-Sound: In a setup without rear speakers (analog stereo output), 3D Sound remixes the six channels of digital surround into a two-speaker output while retaining all of the original audio information. The result is the listening sensation of being surrounded by multiple speakers. During DVD or Video-CD playback, these values can be selected directly with SOUND MODE.

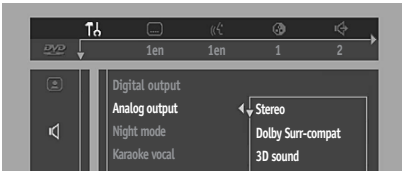

– Night Mode

When set to ON, the dynamics of your sound output are optimized. High volume outputs are softened, enabling you to watch your favorite action movie, etc. without disturbing others.

– Karaoke vocal

Put this setting to ON only when a multi-channel karaoke DVD is being played. The karaoke channels on the disc will then be mixed into a normal stereo sound.

– PCM Output

Allows to select PCM digital output between 48kHz and 96kHz. When 48kHz has been selected, 96kHz PCM data, (if available on disc) will be converted to 48kHz. Some 96kHz DVD are copy protected. If your PCM output selection is 96kHz, the digital output is downsampled to 48kHz.

– Sub-woofer Cut-off

The frequency of the subwoofer output can be set to High (200Hz) or Low (100Hz) to match your system's playback sound quality.

Language

Selecting disc languages:

Menu/Audio/Subtitle language

- This is to select the audio language, subtitle language and the language used in TV screen menus or DVD menus which will always be used for every disc to be played back.
- If the language selected is not available on the disc, the default language designated by each disc will be selected.

Features

– Access Control

Access Control contains the following features:
 Child Lock - When Child Lock is set to ON, a 4-digit code needs to be entered in order to playback discs.

Parental control - Allows the conditional presentation of DVDs containing Parental Control information (see 'Access Control' section).

– Status Window

Displays the current status of the player and appears with the menu bar. When disc playback is stopped, it is displayed with the 'Temporary Feedback Field' in the default screen. See 'On-Screen Display' information;
 Factory setting is ON. Select OFF to suppress display of the Status Window.



– PBC (Playback Control - for VCD)

The Playback Control can be set to ON or OFF (see section "Special VCD & SVCD Features" for details).

– Beeper

The beeper can be set to ON or OFF.

– Help text

When set to ON, help text describes the icons selected. Select OFF if you no longer require the help text.

– Smart Power OFF

Puts the set to standby after a predefined time. This can be set to Enabled or Disabled.

– Wake-up Timer

The wake-up timer allows your player to turn on after a preset time. Whenever the player wakes up, the value of wake up timer is set to zero automatically. The Wake-up Timer will activate when the set is switched to standby-mode.

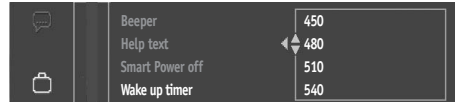

– IntelliPlay

Intelliplay is a convenient feature for automated playback of disc content.

When switched to "ON", the playback will automatically play only disc with similar content (either audio or video) to previous disc while skipping the rest content.

For example, when a CD was played previously, the player will search for the next audio disc in the tray sequence (CD or MP3 disc). (→ Music only)
 Pressing the Disc Direct access to a disc other than a music disc when IntelliPlay is set to ON, will change to video mode. (→ Movie only)



Other Feature

– Bit Rate Indicator

Press CD TEXT/BIT RATE to activate the bit rate indicator. When activated, the bit rate for video and audio, as well as the total bit rate is displayed.

This is only applicable during playback of DVD and SVCD discs.



Operation

Basic Playback

- 1 Press STANDBY/ON on the front panel.
- 2 Press OPEN/CLOSE ▲ on the front panel to open disc loading tray.
- 3 Place the chosen discs in the tray, with the label facing up.
- 4 Press PLAY ►.
→ The disc tray closes and playback starts automatically with all the loaded discs on the tray in sequence.
- 5 To stop playback, press STOP.

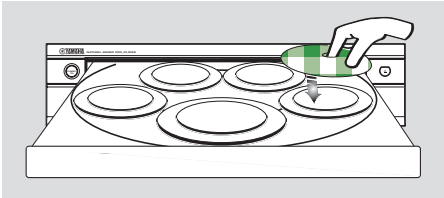

- To playback a specific disc directly, press DISC SKIP repeatedly on the remote control or one of the DISC (1, 2, 3, 4, 5) on the front panel.
- Press PLAYXCHANGE on the front panel to open the disc tray and reload or unload any discs without interrupting current disc playback.
- Playback will stop after all discs have been played.
- When the disc tray is open, pressing PLAY, OPEN/CLOSE, PLAYXCHANGE, DISC (1, 2, 3, 4, 5) will close the disc tray automatically.

Notes:

- DVDs may have a region code. Your player will not play discs that have a region code different from the region code of your player. The region code of this player is stated on the rear panel.
- If 'Child Lock' is set to ON and the disc inserted is not authorized, the 4-digit code must be entered and/or the disc must be authorized (see 'Access Control').

Playing a DVD-Video

- DVD video discs may have one or more TITLES, and each TITLE may have one or more CHAPTERS.
- Playback stops at the end of each TITLE.

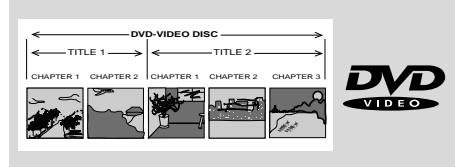

Playing a title

- 1 Press DISC (1, 2, 3, 4, 5) on the front panel or DISC SKIP repeatedly on the remote control to playback a specific disc directly.
→ Playback starts automatically.
- 2 When the MENU appears on the TV screen, use ▼, ▲, ◀, ▶ or numerical keys on the remote control to select an option and continue playback.
- 3 If the titles are numbered, press the numerical keys or use ▲/▼ to select desired title in the menubar.
- 4 To stop playback, press STOP.

Resume

The playback of a disc can be interrupted at any point and then resumed from the point where the playback was last stopped.

- 1 Press STOP to interrupt playback.
→ The help line text appears "Press Stop again to start from beginning" for 5 seconds.
- 2 Pressing PLAY will automatically resume playback from the point where playback was interrupted.
OR
- Press STOP again and then press PLAY,
→ Playback will start from the beginning of the discs.
- If you press PLAY when resume icon appears on the screen, resume playback starts from the point where playback was interrupted.

Note:

- Resume feature is also applicable to VCDs and SVCDs.

Video CD and Super Video CD

The current VCD 2.0 and Super Video CD 1.0 standard features are:

Support following VCD and SVCD formats:

Features	Video CDs 2.0	Super Video CDs 1.0
Video bit rate resolution NTSC resolution PAL	MPEG-1 constant 1,150 Kbps 352x240, 29.97Hz 352x288, 25Hz	MPEG-2 variable up to 2.6 Mbps 480x480 interlaced, 29.97Hz 480x576 interlaced, 25Hz
Still picture (photo) resolution NTSC resolution PAL	MPEG-1 352x240, 704x480 352x288, 704x576	MPEG-2 (1 Frame) 480x480, 704x480 480x576, 704x576
Audio sampling bit rate audio channels surround sound	MPEG-1 layer II 44.1KHz 224Kbps 1 stereo / 2 mono Stereo with Dolby Pro-Logic	MPEG-1 layer II 44.1KHz 32-384Kbps < 2 stereo / 4 mono MPEG-1 (5+1) extension
Overlay graphics/text sub-channels coding		overlay video plane <= 4 4 colour CLUT (2bits/pixel)

Following formats can't be supported in VCD:

- HQ-VCD is encoded at 2.4Mbps or 2.6Mbps
- XVCD (eXtended VCD) with higher resolution and data rate.

- Video CDs may have one or more TRACKS, and TRACKS may have one or more INDEXES.
- To make easy and convenient access, you can move between TRACKS and INDEXES.
- Some Video CDs have Play Back Control (PBC), which is a predefined playback sequence stored on the disc (see "Playback Control" section).

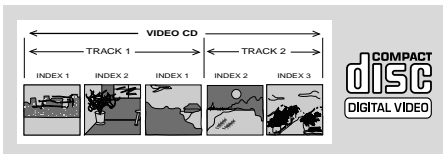

Playing a disc

- 1 Press DISC (1, 2, 3, 4, 5) on the front panel or DISC SKIP repeatedly on the remote control to playback a specific disc directly.
 - Playback starts automatically.
 - The current track number and its elapsed playing time will be displayed.
- 2 To stop playback, press STOP.
- 3 Disc Resume feature is also applicable for VCDs and SVCDs (see "Resume" section).

Playing an Audio CD

- Audio CDs contain only TRACKS.
- They can be played on your DVD player with the audio output connected to a stereo system or to your TV.
- If CD-text is available on the disc, it will be displayed on both the TV screen and player's front display.
- Select tracks using the menubar on the TV screen or by pressing the numerical keys directly.
- Your DVD player also allows you to compile Favorite Track Selection (FTS) programs for your discs by selecting or excluding tracks of your choice (see FTS Program - Audio CDs).

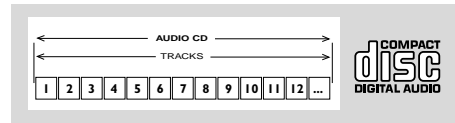

Playing a disc

- 1 Press DISC (1, 2, 3, 4, 5) on the front panel or DISC SKIP repeatedly on the remote control to playback a specific disc directly.
 - Playback starts automatically.
 - The TV screen will display the number of tracks for selection and current playing status.
- 2 At the end of the disc, playback of the next available disc starts. Playback stops after all the discs are played back.
- 3 To stop playback, press STOP.

Operation

Special DVD Features

DVDs may contain menus to navigate the disc and access special features. Press the appropriate numerical key or use **▼**, **▲**, **▶**, **◀** to highlight your selection in the DVD menu and press ENTER/OK to confirm.

Title/Disc menu

- 1 Press MENU.
→ If the current title has a menu, the menu will appear on the screen. Otherwise, the menu will be displayed.
- 2 If menu is available on the disc, audio language, subtitle options, chapters for the title and other options will appear for selection.
- 3 To remove the title/menu, press MENU again.

Camera Angle

Some discs contain scenes which have been shot simultaneously from various angles.

This DVD player allows you to select the desired camera angle.

- When the DVD player encounters a scene shot in multiple angles, it will give an indication on the "Temporary Feedback Field."
→ The angle icon remains displayed until multiple angles are no longer available.
- Use **▲/▼** to select the required angle.
→ Playback changes to the selected angle.
- You can also select **↔** in the menu bar or press ANGLE on the remote control directly.

Changing the audio language

- 1 Select **Ⓜ** in the menu bar or press AUDIO on the remote control directly.
- 2 Press AUDIO or **▲/▼** repeatedly to select the different languages.

Subtitle Language

- 1 Select **Ⓜ** in the menu bar or press SUBTITLE on the remote control directly.
- 2 Press SUBTITLE or **▲/▼** repeatedly to select the different subtitles.

Special VCD & SVCD Features

Playback Control (PBC)

Playback control is a feature on some Video CDs / Super Video CDs that enables interactive use. Video CD discs with Playback Control features enables user to access a selected track directly from the menu.

- 1 Load a Video CD with PBC and press PLAY.
- 2 Go through the menu with the keys indicated on the TV screen until your chosen passage starts to playback. If a PBC menu consists of a list of tracks, you can select a track directly.
- 3 Enter your choice with the numerical keys.
- 4 Press RETURN/RESUME to go back to the previous menu, if applicable on the menu.
- 5 You may also select PBC OFF under Personal Preferences.
→ When set to OFF, PBC menus are not activated for further playback.

Special CD & MP3 Features

CD text and MP3 text

- 1 Some CD or MP3-CD discs may contain text information (eg. track name, album name, artist name etc.) which will appear on the player and TV screen during playback.
- 2 By default, CD text display is set to ON.
- 3 To switch off the CD text display, press CD TEXT/BIT RATE on the remote control during playback.
- 4 Press CD TEXT/BIT RATE on the remote control again to switch on the text display mode.

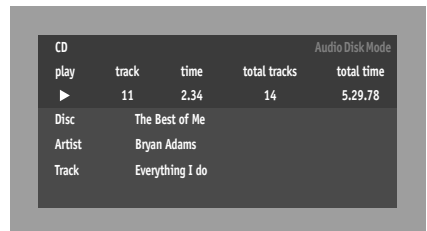

CD		Audio Disk Mode		
play	track	time	total tracks	total time
▶	11	2:34	14	5:29:78
Disc	The Best of Me			
Artist	Bryan Adams			
Track	Everything I do			

General Features

Note:

– Unless stated, all operations described are based on remote control use. Some operations can be carried out using the menu bar on the TV screen.

Moving to another title/chapter



When a disc has more than one title/track or chapter, you can move to another title/chapter as follows:

- 1 Press ON SCREEN, then select T or C in the menu bar.
- 2 Press ▲/▼ or the numerical keys to select a title/chapter.



- 1 Press ►► or ◀◀ briefly during playback to go to the next track or to return to the beginning of the current track respectively.
- 2 Press ◀◀ twice briefly to step back to the previous track.
- 3 To go directly to any track, enter the track number using the numerical keys.

Search



- 1 Select ► in the menu bar and press ▼.
- 2 Use ◀► to select the required speed: -32, -8 or -4 (backward), or +4, +8, +32 (forward).
- 3 Select 1 to play the disc at normal speed again.
- 4 To exit the Search mode, press ▲.



- To search forward or backward through different speeds, you can also hold down ►► or ◀◀ for more than two seconds.

Slow Motion

- 1 Select ► in the menu bar and press ▼.
→ Playback will pause.
- 2 Use ◀► to select the required speed: -1, -1/2, -1/4 or -1/8 (backward), or +1/8, +1/4, +1/2 or +1 (forward).
- 3 Select 1 to play the disc at normal speed again.
- 4 If II is pressed, the speed will be set to zero (PAUSE).
- 5 To exit slow motion mode, press ▲.
(Playback continues at the selected speed.)

Still Picture and Frame-by-frame playback

- 1 Select ► in the menu bar and press ▼.
→ Playback will pause.
- 2 Use ◀► to select the previous or next picture frame.
- Press PLAY to play the disc at normal speed again.

Note:

– You can also activate frame-by-frame playback by pressing PAUSE repeatedly on the remote control.

Scan

Scanning plays the first 10 seconds of each chapter/track on a disc.

- 1 Press SCAN.
- 2 To continue playback at your chosen chapter/track, press SCAN again or press PLAY.

Operation

Repeat



Repeat chapter/title/disc

Each time you press REPEAT, the front display changes as follows:



REPEAT CHPT*: repeat the current chapter
REPEAT TITL: repeat the current title
REPEAT DISC*: repeat the entire disc
RPT ALL DSC: repeat all discs loaded on the tray
REPEAT OFF: exit repeat mode

* This feature may not be available with some discs.



Repeat track/disc

Each time you press REPEAT, the front display changes as follows:



REPEAT TRK: repeat the current track
REPEAT DISC: repeat the entire disc
RPT ALL DSC: repeat all discs loaded on the tray
REPEAT OFF: exit repeat mode

Note:

– When only one disc is available on the disc tray, continuous playback will apply when RPT ALL DISC is selected.

Repeat A-B

– DVD-Video Discs: repeat a sequence in a title

– Video and Audio CDs: repeat a sequence in a disc

- 1 Press A-B at your chosen starting point.
- 2 Press A-B again at your chosen end point.
→ REPEAT A B appears briefly on the front display, and the repeat sequence begins.
- 3 To exit the sequence, press A-B.

Shuffle Across All Discs

Shuffle feature plays all tracks on all loaded discs on the disc tray in random sequence.

- 1 Press SHUFFLE repeatedly during playback.
→ SHUFFLE, SHF ALL DSC, SHUFFLE OFF appears continuously on the front display for about 3 seconds.

Notes:

- DVD Discs will not be included in the "Shuffle across all discs" sequence.
- With VCD 2.0, set the PBC (Playback Control) to Off.

Time search

The Time Search function allows you to start playing at any chosen time on a disc.

- 1 Select in the menu bar and press ▼.
→ Playback will pause.
→ The elapsed playing time is displayed in a time edit box.
- 2 Enter hours, minutes and seconds from left to right in the time edit box using the remote control numerical keys.
→ Each time an item has been entered, the next item will be highlighted.
- 3 Press ENTER/OK to confirm the selected time.
→ The time edit box will disappear and playback starts from the selected time position on a disc.

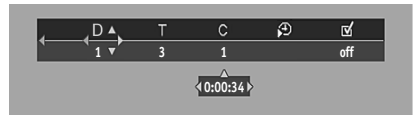

- 4 Press ON SCREEN to remove the menu bar.

Zoom

The Zoom function allows you to enlarge the video image and to pan through the enlarged image.

- 1 Select .
- 2 Press ▲/▼ to activate the ZOOM function and select the required zoom factor: 1.33 or 2 or 4.
→ Playback will continue.
→ The selected zoom factor and 'Press OK to pan' appears below the menu bar.
→ The zoomed picture will appear on the TV screen.
- 3 Press ENTER/OK to confirm the selection.
→ The panning icon appears on the screen.

- 4 Use ◀, ▶, ▲, ▼ to pan across the screen.
- 5 When ENTER/OK is pressed only the panned picture will be shown on the screen.
- 6 To exit ZOOM mode, select zoom factor to "Off" (zoom factor 1) in the menu bar.



Note:

– ZOOM mode gets deactivated when starting playback of next element in FTS across disc and Shuffle across Disc modes.

Favorite Track Selection Across Disc

- This FTS function allows you to create a list favorite tracks by selecting tracks from different discs available in the disc tray.
- The supported discs are CDDA, MP3, VCD, SVCD.
- Favorite Track Selection (FTS) list contains up to 100 elements across all the discs on the tray.

Storing a Program

- 1 Press OPEN/CLOSE and load preferred discs onto the disc tray.
- 2 In STOP mode, select FTS in the menu bar.
- 3 Press ▼ in the menu bar.
→ The FTS window menu appears.
- 4 Select All Discs option.

Storing entire disc as the FTS

- 1 Press ▼ to select DISC.
- 2 Use ▶ and ◀ to select the require disc list for all the loaded discs in the disc tray.
- 3 Press ENTER/OK to store the entire disc selection.

Storing album/title

- 1 Press ▼ to select ALBUM/TRACK. Albums are for MP3 discs and Tracks for (S)VCD.
- 2 Use ▶ and ◀ to select the require Album/Track.
- 3 Press ENTER/OK to store the entire selected Album/Track.
→ The Album/Track. number will be added to the program list.

Storing track/chapter

- 1 Press ▼ on the selected TRACK/INDEX. Tracks are for MP3/CDDA discs and Index for S(VCD).
→ The track/chapter number will be highlighted.
- 2 Use ▶ and ◀ to select the required Track/Index.
- 3 Press ENTER/OK to confirm the selection.
→ The selected Track/Index will be added to the program list.
- 4 Press ON SCREEN to exit the FTS menu.

Switching a Program OFF

- 1 Use ▲/▼ to move to FTS.
- 2 Press ▶ or ◀ to select OFF.
- 3 Press ON SCREEN to exit.

Erasing a selection in a Program

- 1 While playback is stopped, select FTS in the menu bar.
- 2 Use ▼ to select PROGRAM.
- 3 Use ▶ and ◀ to select the required number.
- 4 Press ENTER/OK to erase the selection.
- 5 Press ON SCREEN to exit.

Erasing all selections

- 1 While playback is stopped, select FTS in the menu bar.
- 2 Use ▼ to select CLEAR ALL and press ENTER/OK.
→ All selections will be erased.
- 3 Press ON SCREEN to exit.

Note:

– Pressing PLAYXCHANGE or OPEN/CLOSE during playback will erase the selected Program if any.
– With VCD 2.0, set the PBC (Playback Control) to Off.

FTS for a Single disc

- 1 Select FTS in the menu bar.
- 2 Press ▼ in the menu bar.
→ The FTS window menu appears.
- 3 Select CURRENT DISC option.

Operation

Storing album/title

- 1 Press ▼ to select ALBUM/TRACK. Albums are for MP3 and Tracks for (S)VCD.
- 2 Use ► and ◀ to select the require Album/Track.
- 3 Press ENTER/OK to store the entire selected Album/Track.
→ The Album/Track number will be added to the program list.

Storing track/chapter

- 1 Press ▼ on the selected TRACK/INDEX. Tracks are for MP3/CDDA and Index for (S)VCD.
→ The track/chapter number will be highlighted.
- 2 Use ► and ◀ to select the required Track/Index.
- 3 Press ENTER/OK to confirm the selection.
→ The selected Track/Index will be added to the program list.
- 4 Press ON SCREEN to exit the FTS Menu.

Switching a Program OFF

- 1 Use ▲/▼ to move to FTS.
- 2 Press ► or ◀ to select OFF.

Erasing a selection in a Program

- 1 While playback is stopped, select FTS in the menu bar.
- 2 Use ▼ to select PROGRAM.
- 3 Use ► and ◀ to select the required number.
- 4 Press ENTER/OK to erase the selection.
- 5 Press ON SCREEN to exit.

Erasing all selections

- 1 While playback is stopped, select FTS in the menu bar.
- 2 Use ▼ to select CLEAR ALL and press ENTER/OK.
→ All selections will be erased.
- 3 Press ON SCREEN to exit.

Favourite Track Selection					
FTS	Current Disc	Off	◀ All Discs		
Disc	1 CDDA	2 MP3	3 ANY	4 VCD	5 ANY
Album	1	2	3	4	5
Track	11	◀ 12	▶ 13	14	15
Program	2, 1, 11	2, 1, 12			
	Clear all				

MP3 Disc Features

Support following MP3-CD formats (Joliet format):

- Max. 64 characters (file names or directory)
- Max. nested directory is 8 levels
- The max. album (directory) number is 100
- Supported VBR bit-rate
- Supported sampling frequencies for MP3 disc are: 32 kHz, 44.1 kHz, 48 kHz
- Supported Bit-rates of MP3 disc are: 32, 64, 96, 128, 192, 256 (kbps)

Following formats can't be supported

- The files like *.WMA, *.AAC, *.DLF, *.M3U, *.PLS
- Chinese filenames
- The non-session closed discs
- The discs recorded under UDF format

Downloading MP3 files from the Internet or copying songs from your own legal discs is a delicate process.

Sound Quality	Bit Rate	Approximate Reduction Ratio	Approximate total MP3-CD time	Comment
AM radio	32 kbps	40 : 1	40 hrs	Sound quality significantly affected – not recommended
FM radio	64 kbps	20 : 1	20 hrs	
Near-CD	96 kbps	15 : 1	15 hrs	Balanced sound quality – compression rate
CD-like	128 kbps	10 : 1	10 hrs	
CD*	256 kbps	5 : 1	5 hrs	Compression rate low
CD*	320 kbps	3 : 1	3 hrs	– suggest to play CDs instead

You may experience an occasional “skip” while listening to your MP3 files. This is normal.

Additional note for MP3 disc Playback:

- In compliance with the SDMI, digital-out is muted while playing MP3 discs.
- Due to the recording nature of Digital Audio MP3 (DAM), only Digital Audio music will play.
- The disc reading time may exceed 10 seconds due to the large number of songs compiled onto one disc.
- Playback of multi-session disc is supported for the first 10 sessions with the same format.
- For multi-session discs with different formats, only the first session will be available.
- Some MP3 discs cannot be played depending on the disc characteristics or recording conditions.

Album/Title Playback

This feature allows you to view and select the next or previous MP3 disc Album/Title.

- 1 Press ▲/▼ to scroll through the previous or next Album.
- 2 Press ◀/▶ to scroll through the previous or next Track.
- 3 You can also select the desired album/track number directly using the numeric keys on the remote control.

Notes:

- **In STOP mode:** numbers are used for album selection.
 - **In PLAY mode:** numbers are used for track selection.
- Only the following functions are possible for MP3 discs:
 - STOP / PLAY / PAUSE
 - SKIP NEXT / PREVIOUS
 - REPEAT (TRACK / ALBUM / DISC / ALL DISCS)
 - SHUFFLE ACROSS ALL DISC
 - FTS ACROSS ALL DISC

Repeat track/album/Disc

Each time you press REPEAT, the front display changes as follows;

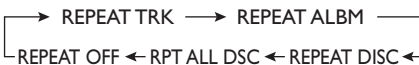

REPEAT TRK: repeat a track

REPEAT ALBM: repeat an album

REPEAT DISC: repeat the current disc





RPT ALL DSC: repeat all discs loaded on the tray

REPEAT OFF: exit repeat mode

Access Control

Child Lock

Activating/deactivating the Child Lock

- 1 When disc playback is stopped, select ACCESS CONTROL in the Personal Preferences menu using ▲/▼.
- 2 Enter a 4-digit code of your own choice twice.
- 3 Move to "CHILD LOCK" using ▲/▼.
- 4 Move to  /  using ►.
- 5 Select  using ▲.
- 6 Press ENTER/OK or ◀ to confirm, then press ON SCREEN to exit the Personal Preferences menu.
→ Now unauthorized discs will not be played unless the 4-digit code is entered.
- 7 Select  to deactivate the CHILD LOCK.

Notes:

Confirmation of the 4-digit code is necessary when:

- The code is entered for the very first time (see above),
- The code is changed or cancelled (see 'Changing the 4-digit code'),

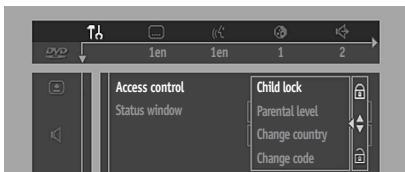

Authorising discs

- 1 Insert the disc.
→ The 'child safe' dialog will appear.
- 2 You will be asked to enter your secret code for 'Play Once' or 'Play Always.'
- If 'Play Once', disc can be played until you select another disc, open the disc tray or turn the player off.
- If 'Play Always', disc will become authorized and can always be played, even if the Child Lock is set to ON.



Notes:

- The player memory can maintain 80 authorized ('Child safe') disc titles. A disc will be placed in the list when 'Play Always' is selected.
- Each time a 'child safe' disc is played, it will be placed on top of the list. When the list is full, the last disc in the list will be replaced when a new disc is added.

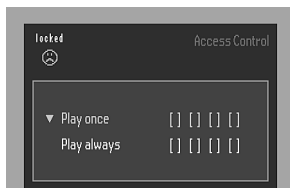
– Double-sided DVDs and multi-volume VCDs may have a different ID for each side. In order to make the disc 'child safe', each side has to be authorized.



Deauthorising discs

- 1 Insert the disc.
→ Playback starts automatically.
- 2 Press ■ while  is visible.
→ The  will appear and the disc is now deauthorized.

Note:

– Playback continues even after you have deauthorized the disc. Press ■ if you want to stop it.

Parental Control

Movies on DVDs may contain scenes not suitable for children. Therefore, discs may contain 'Parental Control' information which applies to the complete disc or to certain scenes on the disc. These scenes are rated from 0 to 8, and alternative, more suitable scenes are available on the disc. Ratings are country dependent. The 'Parental Control' feature allows you to prevent discs from being played by your children or to have certain discs played with alternative scenes.

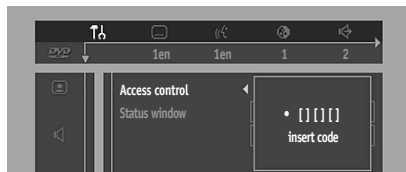

Activating/Deactivating Parental Control

- 1 When disc playback is stopped, select ACCESS CONTROL in the Personal Preferences menu using ▲/▼.
- 2 Enter your 4-digit code. If necessary, enter the code a second time.
- 3 Move to Parental Control using ▲/▼.
- 4 Move to value adjustment ('-' -8) using ►.
- 5 Then use ▲/▼ or the numerical keys on the remote control to select a rating from 1 to 8 for the disc inserted.

Rating 0 (displayed as '—'):

Parental Control is not activated. The Disc will be played in full.

Ratings 1 to 8:

The disc contains scenes not suitable for children. If you set a rating for the player, all scenes with the same rating or lower will be played. Higher rated scenes will not be played unless an alternative which has the same rating or lower is available on the disc. If no suitable alternative is found, playback will stop and the 4-digit code has to be entered.

- 6 Press ENTER/OK or ◀ to confirm, then press ◀ again to exit the Personal Preferences menu.



Country

You can set the DVD player to block or allow DVD playback according to the country rating selected in the DVD.

- 1 When disc playback is stopped, select ACCESS CONTROL in the Personal Preferences menu using ▲/▼.
- 2 Enter the 4-digit code.
- 3 Move to CHANGE COUNTRY using ▼.
- 4 Press ►.
- 5 Select a country using ▲/▼.
- 6 Press ENTER/OK or ◀ to confirm, then press ◀ again to exit the menu.

Changing the 4-digit code

- 1 When disc playback is stopped, select ACCESS CONTROL in the Personal Preferences menu using ▲/▼.
- 2 Enter the current 4 digit code.
- 3 Move to CHANGE CODE using ▼ and press ►.
- 4 Enter the new 4-digit code.
- 5 Enter the code a second time and reconfirm by pressing ENTER/OK.
- 6 Press ◀ to exit the menu.
→ The new 4 digit code will be take effect.

If you forget your 4 digit code

- 1 Press ■ to exit the 'Child Safe' screen.
- 2 Select ACCESS CONTROL in the Personal Preferences menu using ▲/▼.
- 3 The 4-digit code can be cancelled by pressing ■ four times in the 'Access Control' dialog.
- 4 You can then enter a new code (twice) as described above in 'Changing the 4 digit code'.

Parental Control Disclaimer

This player features the PARENTAL CONTROL system which is to activate when playing DVD discs furnished with certain software coding only. Also note that at the time of release of this player, certain aspects of the technical standards had not been settled between set makers and the disc industries.

On this basis, YAMAHA cannot guarantee the functioning of the PARENTAL CONTROL system and denies any liability associated with unintended watching of disc content.

If in doubt, please make sure the disc plays according to your PARENTAL CONTROL settings before you allow children access to the player.

Troubleshooting

WARNING

Under no circumstances should you try to repair the system yourself, as this will invalidate the warranty. Do not open the system as there is a risk of electric shock.

If a fault occurs, first check the points listed below before taking the system for repair.

Problem	Solution
No power	<ul style="list-style-type: none">– Check if the AC power cord is properly connected.
No picture	<ul style="list-style-type: none">– Check if the TV is switched on.– Check the video connection.
Distorted picture	<ul style="list-style-type: none">– Sometimes a small amount of picture distortion may appear. This is not a malfunction.
Completely distorted picture or black/white picture with DVD or Video CD	<ul style="list-style-type: none">– Make sure the NTSC/PAL setting at the DVD player matches the video signal of your television. (See NTSC/PAL Conversion/Settings)
No sound or distorted sound	<ul style="list-style-type: none">– Adjust the volume.– Check that the speakers are connected correctly.
No audio at digital output	<ul style="list-style-type: none">– Check the digital connections.– Check the settings menu to make sure the digital output is set to ALL or PCM.– Check if the audio format of the selected audio language matches your receiver capabilities.
Disc can't be played	<ul style="list-style-type: none">– Ensure the disc label is facing up.– Check if the disc is defective by trying another disc.
Picture freezes momentarily during playback	<ul style="list-style-type: none">– Check the disc for fingerprints/scratches and clean with a soft cloth wiping from center to edge.
No return to start-up screen when disc is removed	<ul style="list-style-type: none">– Reset the player by switching the player off, then on again.
The player does not respond to the remote control	<ul style="list-style-type: none">– Aim the remote control directly at the sensor on the front of the player.– Reduce the distance to the player.– Replace the batteries in the remote control.– Re-insert the batteries with their polarities (+/- signs) as indicated.
Buttons do not work or player stops responding	<ul style="list-style-type: none">– To completely reset the player, unplug the AC cord from the AC outlet for 5-10 seconds.
Player does not respond to some operating commands during playback	<ul style="list-style-type: none">– Operations may not be permitted by the disc. Refer to the instructions of the disc.
This player does not respond to any command when turned on for the first time	<ul style="list-style-type: none">– Turn on your TV and follow the procedures on the screen to decide initial setup items.

PLAYBACK SYSTEM

DVD Video
 DVD+RW
 DVD+R
 Video CD and SVCD
 CD (CD-R and CD-RW)
 MP3 CD

TV STANDARD (PAL/50Hz) (NTSC/60Hz)

Number of lines	625	525
Playback	Multistandard	(PAL/NTSC)

VIDEO PERFORMANCE

YUV output	Y: 1Vpp into 75 ohm Pr/Cr Pb/Cb: 0.7Vpp into 75 ohm
S-Video output	Y: 1Vpp into 75 ohm C: 0.3Vpp into 75 ohm
Video output	1 Vpp into 75 ohm
Black Level Shift	On/Off
Video Shift	Left/Right

AUDIO FORMAT

Dolby Digital/ DTS/MPEG	Compressed Digital
PCM	16, 20, 24 bits fs, 44.1, 48, 96 kHz
MP3 (Joliet)	96, 112, 128, 256 kbps and variable bit rate fs 32, 44.1, 48kHz
Full decoding of Dolby Digital and DTS multi channel sound	
Analog Stereo Sound	
Dolby Surround-compatible downmix from Dolby Digital multi-channel sound	
3D Sound for virtual 5.1 channel sound on 2 speakers	

AUDIO PERFORMANCE

DA Converter	24 bits	
DVD	fs 96 kHz	2 Hz - 44 kHz
CD/Video CD	fs 44.1 kHz	2 Hz - 20 kHz
S-Video CD	fs 48 kHz	2 Hz - 22 kHz
	fs 44.1 kHz	2 Hz - 20 kHz
Signal-Noise (1kHz)		105 dB
Dynamic Range (1kHz)		100 dB
Harmonic Distortion + Noise (1kHz)		0.003%
MPEG MP3		MPEG Audio L3

CONNECTIONS

Y Pb/Cb Pr/Cr (480i/p)	Cinch 3x (green, blue, red)
S-Video Output	Mini DIN, 4 pins
Video Output	Cinch (yellow)
Audio L+R output	Cinch (white/red) x2
Subwoofer output	Cinch (black)
Digital Output	1 coaxial, 1 optical IEC958 for CDDA / LPCM IEC1937 for MPEG1/2, Dolby Digital, DTS

CABINET

Dimensions (w x h x d)	435 x 116 x 425 mm
Weight	Approx. 6 Kg

POWER SUPPLY

Power inlet	U.S.A. model	120V, 60Hz
	Australia model	240V, 50Hz
Power usage		Approx. 20W
Power usage standby		< 5W

* typical playing time for movie with 2 spoken languages and 3 subtitle languages

Specifications subject to change without prior notice.



YAMAHA ELECTRONICS CORPORATION, USA 6660 ORANGETHORPE AVE., BUENA PARK, CALIF. 90620, U.S.A.
YAMAHA CANADA MUSIC LTD. 135 MILNER AVE., SCARBOROUGH, ONTARIO M1S 3R1, CANADA
YAMAHA ELECTRONIK EUROPA G.m.b.H. SIEMENSSTR. 22-34, 25462 RELINGEN BEI HAMBURG, F.R. OF GERMANY
YAMAHA ELECTRONIQUE FRANCE S.A. RUE AMBROISE CROIZAT BP70 CROISSY-BEAUBOURG 77312 MARNE-LA-VALLEE CEDEX02, FRANCE
YAMAHA ELECTRONICS (UK) LTD. YAMAHA HOUSE, 200 RICKMANSWORTH ROAD WATTFORD, HERTS WD1 7JS, ENGLAND
YAMAHA SCANDINAVIA A.B. J A WETTERGRENS GATA 1, BOX 30053, 400 43 VÄSTRA FRÖLUNDA, SWEDEN
YAMAHA MUSIC AUSTRALIA PTY, LTD. 17-33 MARKET ST., SOUTH MELBOURNE, 3205 VIC., AUSTRALIA

YAMAHA CORPORATION
3139 246 12101 Printed in China